

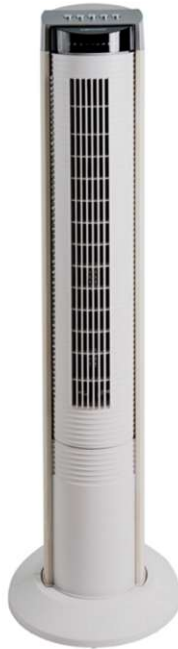

OWNER'S MANUAL

CoolTower CTF09W



(English) (CTF09W)

convair[®]

SAFETY

General Safety

Please read these instructions before using the fan and keep for future reference.

This appliance is not intended for use by persons (including children) with reduced physical, sensory or mental capabilities, or lack of experience and knowledge, unless they have been given supervision or instruction in using the appliance by a person responsible for their safety.

Children should be supervised to ensure that they do not play with the appliance. Do not poke anything through the ventilating slits.

Assemble the fan completely before use.

Always use the fan in an upright position. Stand it on a firm, solid, horizontal base (not on thick pile carpets).

Clean the air inlets and outlets at regular intervals to prevent airflow reduction (refer Maintenance section).

For indoor use only. Do not use this fan outdoors, or on wet surfaces. Do not use the fan near flammable areas or substances.

Electrical Safety

Before connecting your electrical power cord to a power outlet, check that the fan voltage is the same as your power supply. The fan voltage will be stated on the rating label.

Make sure that the fan never comes into contact with water.

Never turn the fan on if the lead is damaged or if the fan's casing is obviously damaged.

If the power supply cord is damaged it must be replaced by the manufacturer, a service agent or similarly qualified persons in order to avoid a hazard.

Do not pull the fan along by the power cord. Always uncoil the power cord completely.

Always turn the fan off and unplug from the power socket when not in use.

ASSEMBLY

Component List

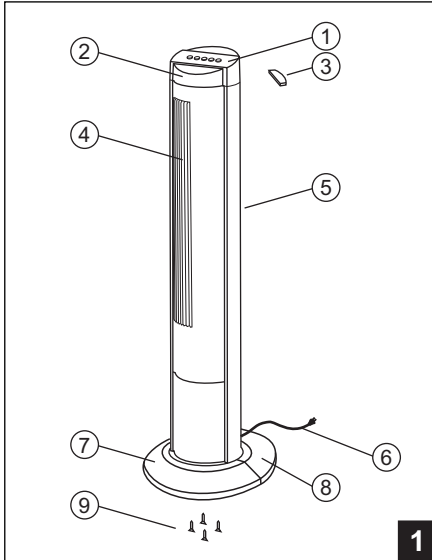

- 1 Control Panel
- 2 Display Panel
- 3 Remote Control
- 4 Air Outlet
- 5 Air inlet
- 6 Power Cord & Plug
- 7 Base Front
- 8 Base Rear
- 9 Screws x 4

Assembly

Unpack the fan and check that you have all of the components.

Remove the screws from the base. Assemble the front and rear base halves together.

Align the screw holes (Fig. 2) on the fan and base. Screw the base stand into position.

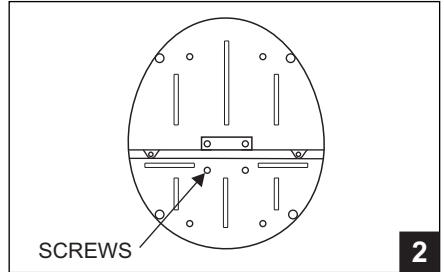

Remote Control Storage

The remote control is stored in the remote control holder located at the top of the rear enclosure as shown in Fig 3.

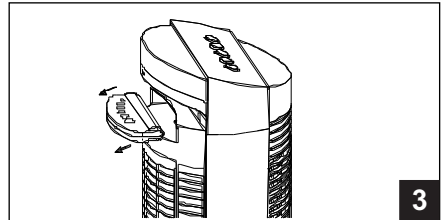

Replacing The Battery

Your remote control is supplied with batteries. Open the battery cover and insert the batteries. Check the polarity is correct and replace the back cover (Fig 4).

The remote control can be used from up to 6m away. Note: if there are two or more fans within this distance, both will be operated by the same remote control.

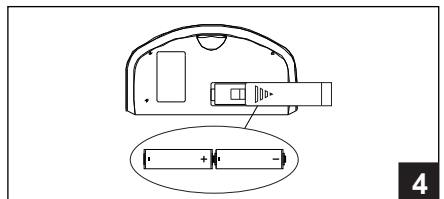



OPERATION



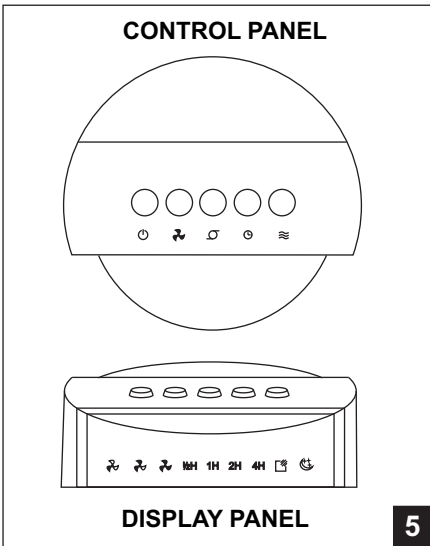

Operation

Insert the power plug into the mains power outlet.

The fan can be controlled by the buttons on the control panel or the remote control (refer Fig. 5 below).



Press the  button to turn the fan ON / OFF.

Press the  button to select the desired fan speed (low , medium  or high ).

Swing Function

Press the  button on the control panel to enable the swing function. The fan will swing from side to side. Press again to stop oscillation.

Note: Do not force or hinder the oscillation movement.

Fan Angles

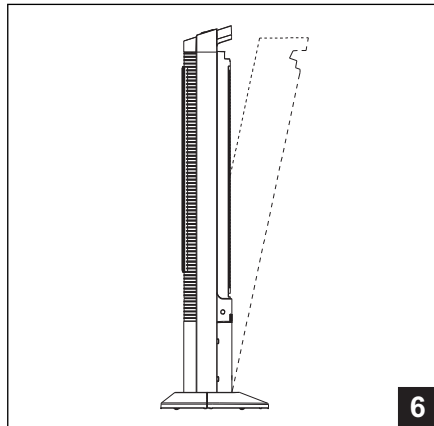

The fan can be inclined backwards as shown in Fig 6. The fan angle selections are 0°, 6° and 12°.





OPERATION

Modes

The fan has 3 modes of operation: Normal, Nature and Sleep. Press the  button to cycle between these modes.

- Normal mode: The fan will work continuously at the selected speed setting. No icon will be displayed.
- Nature mode:  is shown and if set at high speed, the fan will vary between high, medium, low speeds and 'OFF' for 5 seconds each. If the fan speed is set to medium, the fan will cycle between medium, low and 'OFF'. If set to low, the fan will cycle between low and off.
- Sleep mode:  is shown and if set at high speed the fan will first work at high speed nature mode for 30 min, then at medium speed nature mode for 30 min, then continue working at low speed nature mode.

Timer Function

The fan has a timer function that will turn off the fan. By pressing the  button, a 0.5 to 7.5 hour delay will be shown ().

The timer will count down as it progresses - i.e. if 2 hours is set, after 30 minutes 1.5 hours will show as the remaining time on the display. To cancel, touch the  button until the timer indicators are no longer lit.

Maintenance

To maximise the efficiency of the fan, clean the inlet and outlet grilles regularly.

- Unplug the fan from the mains power supply before cleaning.
- Use a soft, damp cloth to wipe the outside. Never use thinners or other strong chemicals on the fan surfaces.
- Use a vacuum cleaner to remove dirt and dust from the inlet and outlet grilles.
- Ensure the fan is dry before plugging back into the mains power supply.



Waste electrical products must not be disposed of with household waste. This product should be taken to your local recycling centre for safe treatment.

WARRANTY

In this warranty:

We or us means Seeley International Pty Ltd ABN 23 054 687 035, and our contact details are set out at the end of this warranty;

You means you, the original end-user purchaser of the Goods;

Supplier means the authorised distributor or retailer of the Goods that sold you the Goods in Australia; and

Goods means the product, unit, appliance or equipment which was accompanied by this warranty and purchased in Australia.

Our Goods come with guarantees that cannot be excluded under the Australian Consumer Law. You are entitled to a replacement or refund for a major failure and for compensation for any other reasonably foreseeable loss or damage. You are also entitled to have the Goods repaired or replaced if the Goods fail to be of acceptable quality and the failure does not amount to a major failure.

In addition to any rights and remedies that You may have under the Australian Consumer Law or any other law, subject to the terms of this warranty, We provide the following warranty:

1. If, during the first 24 months from the date of first retail purchase (**Warranty Period**), the Goods upon examination prove defective by reason of improper workmanship or material, We will replace the Goods or any part thereof without charge. We may substitute any similar good (including a portable tower fan (or other portable cooling product) of a different size or shape), even if it is not on our current price/equipment list. Alternatively, at our sole discretion, we may choose to arrange a refund of the purchase price you paid.

•2. We are under no obligation to replace the Goods under clause 1 if the Goods have not been used only for personal, domestic or household purposes and have not been installed/mounted (if relevant), operated, and maintained in accordance with the instructions in the Owner's Manual. The addition of any third party device or the removal or the alteration of any of our components will void this warranty. In addition, the warranty granted under clause 1 does not apply to:

- Adjustments necessary due to misuse of the appliance,
- Normal user maintenance,
- Setting of controls,
- Transit damage, or
- Damage caused by user misuse, tampering, or failure to observe the care and special provisions in the instructions.

3. The warranty granted under clause 1 is limited to replacement only. As far as the law permits, We will not be liable for any consequential loss suffered through, or resulting from, the non operation, or ineffective operation of the Goods. The warranty granted under clause 1 does not cover damage to the Goods or other loss resulting from acts of God.

4. No other person, firm or corporation is authorised by us to offer or give on our behalf any other or greater warranty than that given under this warranty. The benefits conferred by this warranty are in favour of You and any person deriving title to the goods through or under such person and are intended to be separate from and additional to all other rights and remedies that they may have in law in respect of the goods.

5. We are not responsible in any way for any failure and/or inadequate performance of the Goods which arises from or is connected to the use in the Goods of non-genuine spare parts. We strongly recommend that only spare parts supplied or approved by us are used in the Goods.

6. In order to claim under the warranty granted under clause 1 You must within the Warranty Period return the Goods to the Supplier at the place of purchase together with the proof of purchase.

7. Alternatively, you may claim under the warranty granted under clause 1 by within the Warranty Period returning the Goods to us at the address below together with: (i) a covering letter which states your name and address, daytime telephone number, and model and serial number of the goods, (ii) the legible and unmodified proof of purchase, which clearly indicates the name and address of the original retailer, the date and place of purchase, and the product name or other product serial number, and (iii) a copy of the completed Warranty Information below.

8. This warranty does not cover the cost of claiming under the warranty, it is your responsibility to cover all forwarding and freight costs incurred in returning the Goods to the Supplier at the place of purchase or us.

WARRANTY cont.

9. This warranty is only valid and enforceable in Australia.

Our liability under this warranty is limited to the extent permitted by law. That is, to the extent that it is fair and reasonable, if the Goods are not of a kind ordinarily acquired for personal, domestic or household use or consumption, your remedies associated with any failure or defect of the Product will be limited to:

- (a) the replacement of the Goods or the supply of equivalent goods;
- (b) the repair of the Goods;
- (c) the payment of the cost of replacing the Goods or of acquiring equivalent goods; or
- (d) the payment of the cost of having the Goods repaired

and subject to the terms and conditions included in this warranty.

For technical assistance before returning the product please contact:

1300 650 399

Please retain your receipt as proof of purchase. Every request for warranty must be accompanied by proof of purchase.

WARRANTY INFORMATION

Please complete the following information:

Serial Number:

Product: Convair

Model: CTF09W

Purchased from:

Date purchased:/...../.....

You can also register your warranty online by visiting www.seeleyinternational.com and following these steps:

- Step 1** Select 'GET SUPPORT' and 'REGISTER A WARRANTY'
- Step 2** Select the brand of product you purchased
- Step 3** Enter the required information and then 'Submit'

Service Department
 Seeley International Pty Ltd
 112 O'Sullivan Beach Road
 Lonsdale, South Australia 5160
 Technical assistance in Australia: 1300 650 399
 Website: www.seeleyinternational.com

PRIVACY NOTICE

Seeley International Pty Ltd ABN 23 054 687 035 will use the personal information you provide us with to provide warranty support for the product you have purchased and to inform you about other products and services. If you choose not to supply us with the information requested, we may be unable to provide you with warranty support. We may also disclose your information to third parties, such as related entities; retailers, distributors, service agents and contractors who are affiliated with us; or marketing or market research companies. If you would prefer not to receive direct marketing communications from us, please follow the instructions to "unsubscribe" which will be included in the direct marketing communications we send you, or contact our Privacy Officer using the details set out below. While we do not currently transfer personal information to overseas recipients or store personal information overseas, if we transfer your information to third parties who do so, we will take reasonable steps to ensure that the overseas recipients do not breach the *Australian Privacy Principles*. By registering your warranty, you consent to having your personal information used in this way. Please read our Privacy Policy on our website www.seeleyinternational.com for further explanation of how we collect, use, hold and disclose personal information, and how you may access and seek correction of your information. It also sets out how you may complain about a breach of the Australian Privacy Principles, and how we will deal with your complaint. You may contact us at: Privacy Officer, Seeley International Pty Ltd, 112 O'Sullivan each Road, Lonsdale, South Australia 5160.

It is the policy of Seeley International to introduce continual product improvement. Accordingly, specifications are subject to change without notice. Please consult with your dealer to confirm the specifications of the model selected.



Service

Australia 1-300-650-399

seeleyinternational.com

convair®