

AIRA

By SEELEY INTERNATIONAL ™

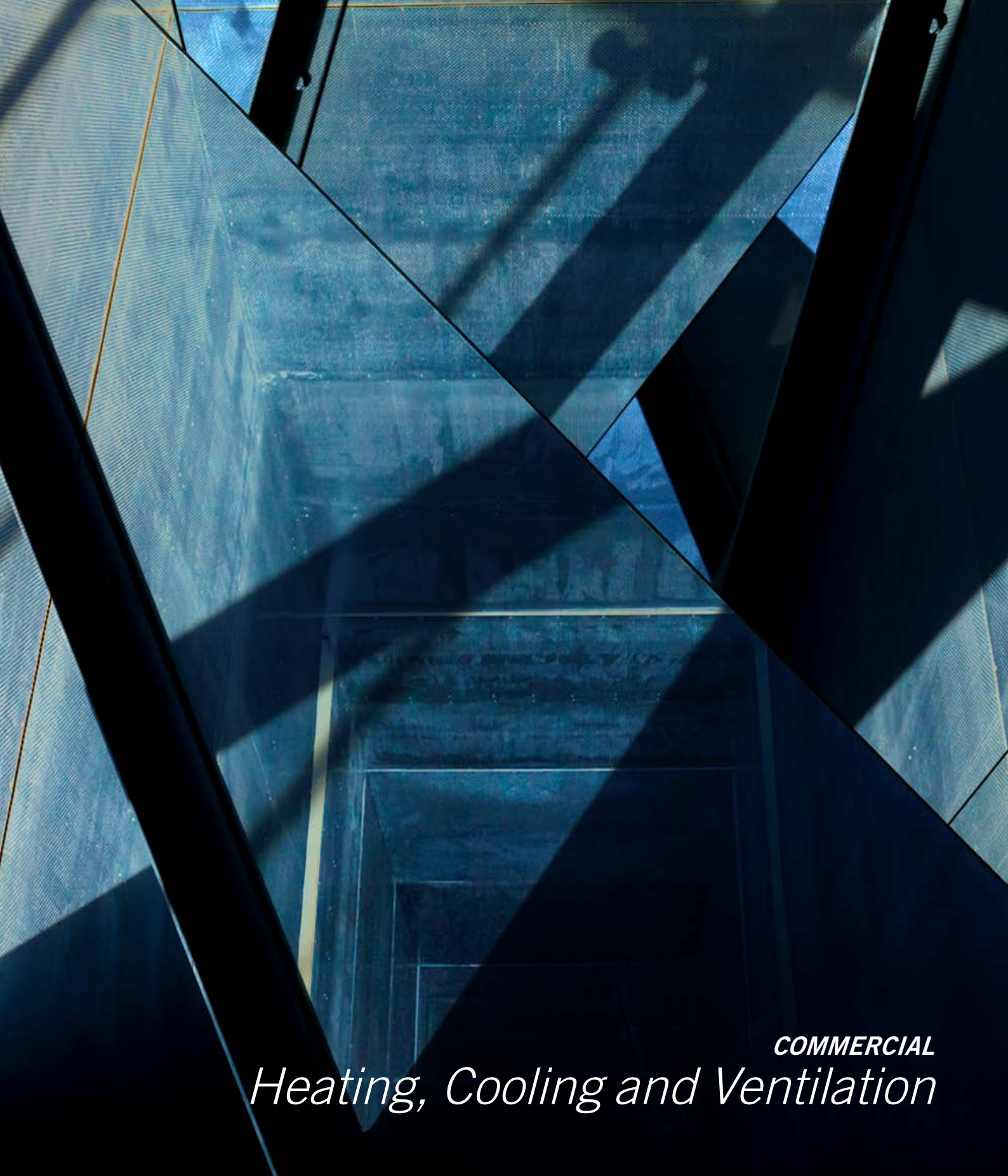

COMMERCIAL
Heating, Cooling and Ventilation

World leading climate control solutions



Australian designed, made and owned!

Built by Australians, for an Australian climate. Seeley International is proudly a 100% Australian owned company, designing and manufacturing world-leading commercial air conditioning solutions for Australia and the world. As Australia's largest air conditioning manufacturer, we are a global leader in developing ingenious, energy-efficient cooling and heating products.

Being made in Australia, you can rely on consistency of supply, build quality, availability of parts and after sales service. We're dedicated to strengthening the Australian economy, supporting local employment and building on the skills of our workforce.



AIRA

By SEELEY INTERNATIONAL
Commercial evaporative air conditioners, heaters & HCV

The Climate Wizard

By SEELEY INTERNATIONAL
Hyper-efficient indirect evaporative air conditioners

Braemar
By SEELEY INTERNATIONAL

Refrigerated air conditioning range including VRF (heat pump and heat recovery) industrial & commercial evaporative air conditioners

Award Winning Company

Seeley International consistently wins awards each year for new product design, innovation and the environment.



Built to purpose and standard high performance energy efficient solutions

AIRA offers high performing evaporative coolers, direct and indirect gas fired heaters, radiant tube heating and HCV (heating cooling ventilation) equipment to the commercial and industrial market.

Produced by Australia's largest and most awarded air conditioning manufacturer, AIRA provides economical, high performing and energy efficient solutions. Solutions which are adaptable to suit a wide range of applications.



COST EFFECTIVE
Economical, energy efficient solutions



AUSTRALIAN
Designed and manufactured in Australia by an Australian owned family company



QUALITY
High performance, leading technology and innovation come as standard



RANGE
Extensive range that is adaptable to suit a wide range of applications



ENVIRONMENT
Energy efficient cooling solutions



TECHNICAL SUPPORT
A team of experienced design consultants and application engineers

Evaporative Coolers

Energy efficient evaporative coolers in a variety of sizes and capacities. Designed for large areas such as factories, warehouses, stadiums and clubs.



AL Series Evaporative cooler



ALA Series Compact wall mounted evaporative cooler

Heating, Cooling and Ventilation

Energy efficient and lightweight units that combine gas heating with evaporative cooling. Flexible installation options make this unit ideal for large open spaces including factories, warehouses, sporting facilities, hotels and clubs.



HCV/HCVR Series Heating, cooling and ventilating units

High Capacity Gas Heaters

Gas heaters that can be combined with cooling systems or operated as a stand alone heater. Includes indirect and direct fired gas heaters and radiant heating. Designed for factories, warehouses, showrooms, door curtains and more.



DU/SD Series Gas heaters



DU-F Series Gas heaters

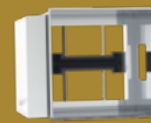

GDH Series Direct fired duct heaters

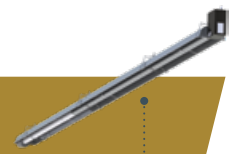

*ATH Series Radiant tube heaters**

*not manufactured by Seeley International

AL Series

Evaporative Coolers

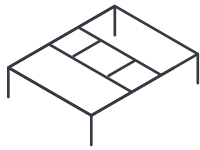
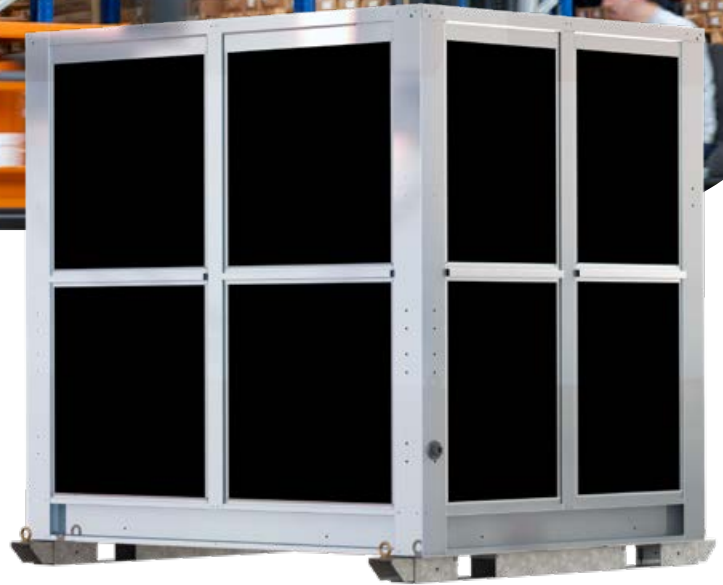

ROOF STAND

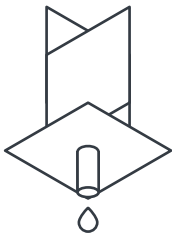

AUTO DRAIN KIT

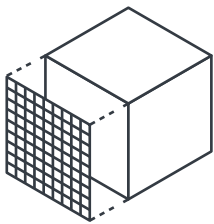

PAD PROTECTION COVER

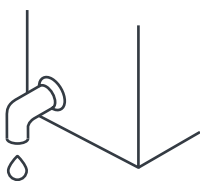

EXTERNAL WATER CONNECTION

The pinnacle of quality, these evaporative coolers are energy efficient, cost effective and designed for large open spaces such as factories and large warehouses.

FEATURES

- Side, top and down discharge
- 1,500 to 22,650 L/s airflow
- Heavy duty, marine grade aluminium cabinet
- Non-corrosive low content water reservoir
- Heavy duty centre hung forward curve, belt drive blowers
- Strong easy grip pad handles for easy maintenance
- Mini-Cell[^] Chillcel[®] pad technology
- External water connection and float pre-fitted

OPTIONS

- Variable pitch adjustable galvanised roof stand
- Aluminium louvre covers
- Automatic drain valve and water management kit
- Aira GDH and DU/SD heater connectable
- Bushfire ember screen
- Filter panels
- Stainless steel fabrication
- Crane lifting lugs for installation.

[^]Patent pending

AL Series

Evaporative Coolers

SPECIFICATIONS

Model		AL18	AL25	AL30	AL36
Cooling Performance	Max Airflow @ 2.5m/s (L/s)	4650	10100	14450	22650
	Max Airflow @ 2.0m/s (L/s)	3800	8400	12000	18100
Electrical Services	Voltage (V/Ph/Hz)	415/3/50	415/3/50	415/3/50	415/3/50
	Max Power (kW)	3.2	5.7	7.7	15.2
Water Services	Supply	20 L/min @ 100 - 800 kPa	20 L/min @ 100 - 800 kPa	20 L/min @ 100 - 800 kPa	20 L/min @ 100 - 800 kPa
	Max Temp	40°C	40°C	40°C	40°C
	Inlet	1/2" (15mm) Male BSP	1/2" (15mm) Male BSP	1/2" (15mm) Male BSP	1/2" (15mm) Male BSP
	Drain	1½" (40mm) Male BSP	1½" (40mm) Male BSP	1½" (40mm) Male BSP	1½" (40mm) Male BSP
Duct Connections	Orientation	Side, Top or Down Discharge Available	Side, Top or Down Discharge Available	Side, Top or Down Discharge Available	Side, Top or Down Discharge Available
Controller	Standard	Wall Switch	Wall Switch	Wall Switch	Wall Switch
Fan	Type	Centrifugal	Centrifugal	Centrifugal	Centrifugal
	Diameter (Inch)	18	25	30	36
	Capacity	High	High	High	High
Motor	Type	3 Phase	3 Phase	3 Phase	3 Phase
	Speed (RPM)	1440	1440	1440	1440
	Output* (kW)	3.0	5.5	7.5	15.0
	Rated (A)	6.41	11.2	14.6	27.4
	Rating	IP55	IP55	IP55	IP55
Pump	Type	Centrifugal	Centrifugal	Centrifugal	Centrifugal
	Motor	Synchronous	Synchronous	Synchronous	Synchronous
	Power (W)	30	30	30	30
	Flow Rate (L/min)	21	21	21	21
	Voltage (V/Ph/Hz)	230/1/50	230/1/50	230/1/50	230/1/50
	Rating	IPX4	IPX4	IPX4	IPX4
Cooling Pads	Size (mm)	700 x 900 (3 Pads)	575 x 1175 (6 Pads)	575 x 1530 (4 Pads) 745 x 1530 (2 Pads)	575 x 1750 (9 Pads)
	Pad Area (m ²)	1.89	4.05	5.80	9.06
Dimensions	Shipping WxDxH (mm)	1200 x 1250 x 1400	1650 x 1700 x 1745	1800 x 2500 x 2060	2300 x 2300 x 2275
	Operating WxDxH (mm)	990 x 990 x 1250	1550 x 1550 x 1570	1550 x 1890 x 1920	2240 x 2230 x 2135
Weight	Shipping (kg)	150	335	410	685
	Operating (kg)	159	353	434	738

*Motor power may change dependant on required airflow and pressure

ALA Series

Wall Mounted Evaporative Coolers



AXIAL FAN

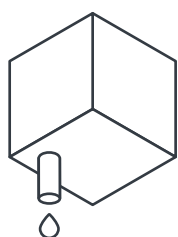

AUTO DRAIN KIT

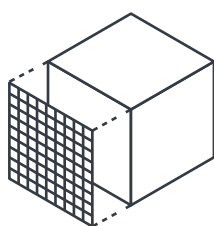

PAD PROTECTION COVER

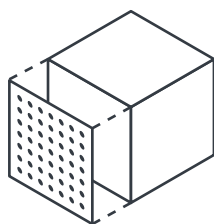

BALL GUARD



Energy efficient, cost effective and compact evaporative wall mounted coolers that are designed for large areas such as warehouses and stadiums.

FEATURES

- Economical form of cooling
- Compact design
- 11,300 L/s airflow
- Mini-Cell[^] Chillcell[®] pad technology
- Heavy duty, marine grade aluminium cabinet
- Non-corrosive low content water reservoir
- Axial fan
- Easy installation

OPTIONS

- Auto drain kit
- Ball guards
- Colour matching option
- Pad protection covers

SPECIFICATIONS

Model	ALA1200
Fan Speed (L/s)	11300
Height (mm)	2055
Width (mm)	1550
Depth (mm)	1036 (+300)
Weight (kg)	130
Motor (kW)	11.2

40mm overflow
15mm BSP water
optional auto drain kit.

[^]Patent pending

HCV / HCVR Series

Heating, Cooling and Ventilating Units

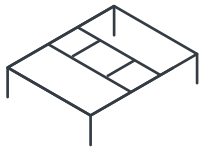

ROOF STAND

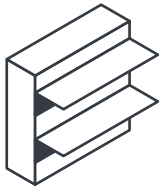

MOTORISED DAMPERS

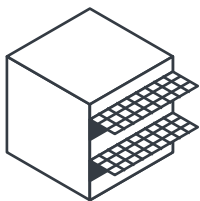

LOUVRE COVERS

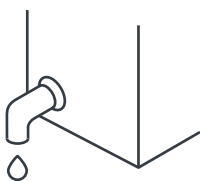

EXTERNAL WATER CONNECTION

Energy efficient and lightweight units that combine gas heating with evaporative cooling. Flexible installation options make this unit ideal for large open spaces including factories, warehouses, sporting facilities, hotels and clubs.

FEATURES

- Full fresh air (HCV) or optional return air heating (HCVR)
- Modulating atmospheric gas burner with dual sensing (room and duct air outlet) for optimum temperature control
- Heavy duty, marine grade aluminium cabinet
- Mini-Cell[^] Chillcell[®] pad technology
- External water connection, solenoid, float and transformer pre-fitted
- 29 - 120 kW heating capacity. Up to 16,000 l/sec evaporative cooling airflow
- Non-corrosive low content water reservoir
- Heavy duty centre hung forward curve, belt drive blowers
- Motorised outlet damper for low speed cooling and heating
- Long life stainless steel heat exchanger
- Indirect gas fired heater

OPTIONS

- Engineered galvanised roof stand
- Motorised dampers
- Aluminium louvre covers
- Mesh cover
- Crane lifting lugs for installation.
- Natural gas fired, optional LPG

Heating, Cooling and Ventilating Units

SPECIFICATIONS

Model		HCV12	HCV16	HCV26	HCV30	HCV35	HCV40	HCV50	HCV60
Configuration	Type	SINGLE HEAT EXCHANGER						DUAL HEAT EXCHANGER	
Heating Performance	Airflow 28°C Temp Rise	840	1118	1784	2100	2454	2785	3568	4200
	Airflow 11°C Temp Rise	2098	2800	4460	5240	6316	6985	8920	10478
	Input NG (LPG) MJ/hr	138 (127)	184 (169)	246 (274)	287 (290)	349 (349)	390 (422)	2x 246 (274)	2x 287 (290)
	Output NG (LPG) kW	29 (26)	38 (35)	51 (44)	60 (51)	73 (62)	88 (81)	2x 51 (44)	2x 60 (51)
Electrical Services	Voltage (V/Ph/Hz)	415/3/50	415/3/50	415/3/50	415/3/50	415/3/50	415/3/50	415/3/50	415/3/50
	Max Power	3.3	3.3	4.3	5.8	7.8	11.3	11.3	15.3
Water Services	Supply (kPa)	20 L/min @ 100 - 800	20 L/min @ 100 - 800	20 L/min @ 100 - 800	20 L/min @ 100 - 800	20 L/min @ 100 - 800	20 L/min @ 100 - 800	20 L/min @ 100 - 800	20 L/min @ 100 - 800
	Max Temp	40°C	40°C	40°C	40°C	40°C	40°C	40°C	40°C
	Inlet	15mm Male BSP	15mm Male BSP	15mm Male BSP	15mm Male BSP	15mm Male BSP	15mm Male BSP	15mm Male BSP	15mm Male BSP
	Drain	40mm Male BSP	40mm Male BSP	40mm Male BSP	40mm Male BSP	40mm Male BSP	40mm Male BSP	40mm Male BSP	40mm Male BSP
Duct Connections	Orientation	Side Discharge	Side Discharge	Side Discharge	Side Discharge	Side Discharge	Side Discharge	Side Discharge	Side Discharge
Controller	Standard	BMS Interface	BMS Interface	BMS Interface	BMS Interface	BMS Interface	BMS Interface	BMS Interface	BMS Interface
	Optional	Rotary Switch	Rotary Switch	Rotary Switch	Rotary Switch	Rotary Switch	Rotary Switch	Rotary Switch	Rotary Switch
Fan	Type	Centrifugal	Centrifugal	Centrifugal	Centrifugal	Centrifugal	Centrifugal	Centrifugal	Centrifugal
	Diameter (Inch)	18	18	25	25	30	30	30	36
	Capacity	High	High	High	High	High	High	High	High
Motor	Type	3 Phase	3 Phase	3 Phase	3 Phase	3 Phase	3 Phase	3 Phase	3 Phase
	Speed (RPM)	1440	1440	1440	1440	1440	1440	1440	1440
	Output/Power* (kW)	3.0	3.0	4.0	5.5	7.5	11.0	11.0	15.0
	Rated (A)	6.41	6.41	8.43	11.2	14.6	21.6	21.6	27.4
	Frame Size	B56	B56	100L	100L	100L	100L	100L	100L
	IP Rating	55	55	55	55	55	55	55	55
Pump	Type	Centrifugal	Centrifugal	Centrifugal	Centrifugal	Centrifugal	Centrifugal	Centrifugal	Centrifugal
	Quantity	1	1	1	1	1	1	1	1
	Power (W)	30	30	30	30	30	30	30	30
	Flow Rate (L/min)	21	21	21	21	21	21	21	21
	Voltage (V/Ph/Hz)	230/1/50	230/1/50	230/1/50	230/1/50	230/1/50	230/1/50	230/1/50	230/1/50
	Rating	IPX4	IPX4	IPX4	IPX4	IPX4	IPX4	IPX4	IPX4
Gas Supply LPG (Propane)	Max/Min (KPa)	3.5/2.74	3.5/2.74	3.5/2.74	3.5/2.74	3.5/2.74	3.5/2.74	3.5/2.74	3.5/2.74
Gas Supply Natural Gas	Max/Min (kPa)	3.5/1.12	3.5/1.12	3.5/1.12	3.5/1.12	3.5/1.12	3.5/1.12	3.5/1.12	3.5/1.12
Test Point LPG (Propane)	High/Low (kPa)	2.5/0.875	2.5/0.875	2.5/0.875	2.5/0.875	2.5/0.875	2.5/0.875	2.5/0.875	2.5/0.875
Test Point Natural Gas	High/Low (kPa)	0.875/0.30	0.875/0.30	0.72/0.30	0.72/0.30	0.72/0.30	0.72/0.30	0.72/0.30	0.72/0.30
Injectors/Burners	Number	6	8	12	14	17	19	24	28
Cooling Pads	Size (mm)	700 x 900 (3 Pads)	700 x 900 (3 Pads)	575 x 1175 (6 Pads)	575 x 1175 (6 Pads)	575 x 1530 (4 Pads) 745 x 1530 (2 Pads)	575 x 1530 (4 Pads) 745 x 1530 (2 Pads)	745 x 1765 (6 Pads)	745 x 1765 (4 Pads) 545 x 1765 (3 Pads)
	Pad Area (m ²)	1.89	1.89	4.05	4.05	5.8	5.8	7.89	8.29
Dimensions	Shipping WxDxH (mm)	1200 x 2400 x 1495	1200 x 2400 x 1495	2400 x 2900 x 1810	2400 x 2900 x 1810	2400 x 2900 x 2160	2400 x 2900 x 2160	2600 x 3700 x 2145	2600 x 3700 x 2145
	Operating WxDxH (mm) (Without flue)	995 x 2141 x 1252	995 x 2141 x 1252	1556 x 2694 x 1570	1556 x 2694 x 1570	1893 x 2695 x 1918	1893 x 2695 x 1918	2240 x 2876 x 1905	2510 x 3566 x 2235
Weight	Shipping (kg)	278	298	510	541	669	691	810	833
	Operating (kg)	309	329	551	582	726	748	867	908

DU/SD Series

Gas heaters



CENTRIFUGAL FAN



ROOM THERMOSTAT

An energy efficient, full fresh air or return air indirect fired high capacity gas heater. Can be combined with cooling or energy recovery systems making them ideal for factories, warehouses, showrooms and schools.

Often coupled with an evaporative cooler as a heating, cooling and ventilation unit.

FEATURES

- 29 to 146 kW heating output capacity
- Adjustable temperature rise using factory air balancing damper
- Internal or external installation
- Stainless steel heat exchanger
- Natural gas fired, optional LPG
- Range of control options: wall controller or BMS
- Optional blower
- Modulating burner control
- Marine grade aluminium cabinet

DU/SD Series

Gas heaters

SPECIFICATIONS

Model		DU12	DU16	SD26	SD30	SD35	SD40	SD51	SD60	SD70	
Configuration	Type	SINGLE HEAT EXCHANGER						DUAL HEAT EXCHANGER			
	Airflow 28°C Temp Rise (L/s)	840	1118	1784	2100	2454	2785	3568	4200	4908	
Heating Performance	Airflow 11°C Temp Rise (L/s)	2098	2800	4460	5240	6316	6985	8920	10478	12272	
	Input NG (LPG) MJ/hr	138 (127)	184 (169)	246 (274)	287 (290)	349 (349)	390 (422)	2x 246 (274)	2x 287 (290)	2x 349 (349)	
	Output NG (LPG) kW	29 (26)	38 (35)	51 (44)	60 (51)	73 (62)	88 (81)	2x 51 (44)	2x 60 (51)	2x 73 (62)	
Electrical Services	Voltage (V/Ph/Hz)	240/1/50	240/1/50	415/3/50	415/3/50	415/3/50	415/3/50	415/3/50	415/3/50	415/3/50	
	Max Power	1.3	1.3	2.4	3.2	4.2	5.2	4.6	6.2	8.2	
Duct Connections	Orientation	Side Discharge	Side Discharge	Side Discharge	Side Discharge	Side Discharge	Side Discharge	Side Discharge	Side Discharge	Side Discharge	
Controller	Standard	BMS Interface	BMS Interface	BMS Interface	BMS Interface	BMS Interface	BMS Interface	BMS Interface	BMS Interface	BMS Interface	
	Optional	Wall Switch	Wall Switch	Wall Switch	Wall Switch	Wall Switch	Wall Switch	Wall Switch	Wall Switch	Wall Switch	
Fan	Type	Centrifugal	Centrifugal	Centrifugal	Centrifugal	Centrifugal	Centrifugal	Centrifugal	Centrifugal	Centrifugal	
	Diameter (Inch)	12	12	15	15	15 x 11 Dual	15 x 11 Dual	2 x 15	2 x 15	2 x 15 x 11	
	Capacity	High	High	High	High	High	High	High	High	High	
Motor	Type	CS & R	CS & R	3 Phase	3 Phase	3 Phase	3 Phase	3 Phase	3 Phase	3 Phase	
	Speed (RPM)	1440	1440	1440	1440	1440	1440	1440	1440	1440	
	Output/Power* (kW)	1.1	1.1	2.2	3.0	4.0	5.5	2 x 2.2	2 x 3.0	2 x 4.0	
	Rated (A)	7.1	7.1	4.9	6.4	8.4	11.2	4.9 / motor	6.4 / motor	8.4 / motor	
	Frame Size	B56	B56	100L	100L	100L	100L	100L	100L	100L	
	IP Rating	21	21	55	55	55	55	55	55	55	
Gas Supply LPG (Propane)	Max/Min (KPa)	3.5/2.74	3.5/2.74	3.5/2.74	3.5/2.74	3.5/2.74	3.5/2.74	3.5/2.74	3.5/2.74	3.5/2.74	
Gas Supply NG	Max/Min (kPa)	3.5/1.12	3.5/1.12	3.5/1.12	3.5/1.12	3.5/1.12	3.5/1.12	3.5/1.12	3.5/1.12	3.5/1.12	
Test Point LPG (Propane)	High/Low (kPa)	2.5/0.875	2.5/0.875	2.5/0.875	2.5/0.875	2.5/0.875	2.5/0.875	2.5/0.875	2.5/0.875	2.5/0.875	
Test Point NG	High/Low (kPa)	0.875/0.30	0.875/0.30	0.72/0.30	0.72/0.30	0.72/0.30	0.72/0.30	0.72/0.30	0.72/0.30	0.72/0.30	
Injectors/Burners	Number	6	8	12	14	17	19	24	28	34	
Dimensions	Shipping (blower) DxWxH (mm)	1835 x 995 x 1252	1835 x 995 x 1252	1835 x 1556 x 1570	1835 x 1556 x 1570	1835 x 1890 x 1918	1835 x 1890 x 1918	1555 x 2730 x 1555	1555 x 2730 x 1555	1555 x 3135 x 1555	
	Operating (no blower) DxWxH (mm)	920 x 995 x 1252	920 x 995 x 1252	920 x 1556 x 1570	920 x 1556 x 1570	1835 x 1890 x 1918	1835 x 1890 x 1918	1025 x 2730 x 1555	1055 x 2730 x 1555	775 x 3135 x 1555	
Weight	Shipping (Inc blower) (kg)	290	300	415	425	515	545	875	895	1085	

GDH Series

Direct fired gas duct heaters

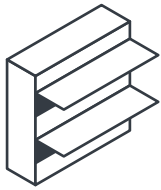

MOTORISED DAMPERS

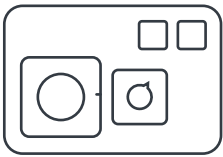

CONTROL PANEL

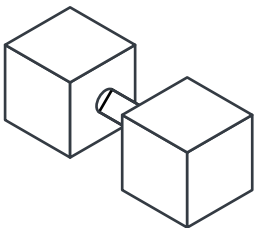

**COUPLING WITH
EVAPORATIVE COOLER**

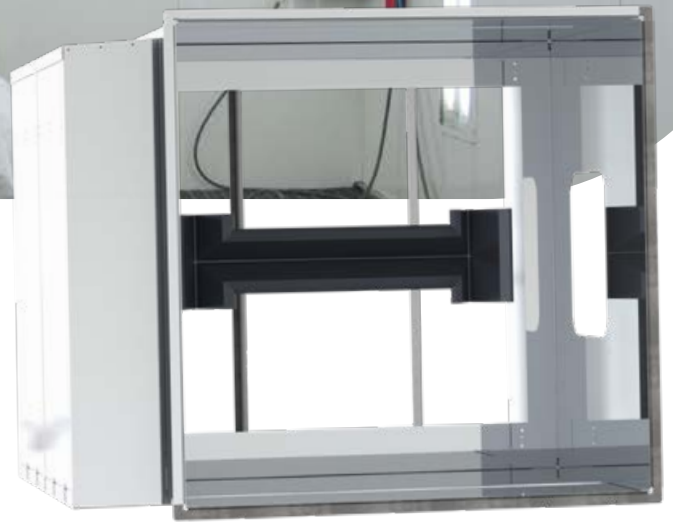

An energy efficient, direct fired gas duct heater, delivering high air volume to heat output ratio. Can be combined with evaporative coolers making them ideal for factories, warehouses and showrooms.

FEATURES

- 220 to 694 kW capacity
- Electronic ignition and on/off with intermittent fan
- Internal or external installation for 100% outside air applications
- Horizontal or vertical units available for horizontal or vertical up-blast applications
- Aluminium burner
- Automatic ignition

OPTIONS

- Modulating burner
- Control panel
- Motorised dampers
- Natural gas fired, optional LPG

GDH Series

Direct fired duct heaters

SPECIFICATIONS

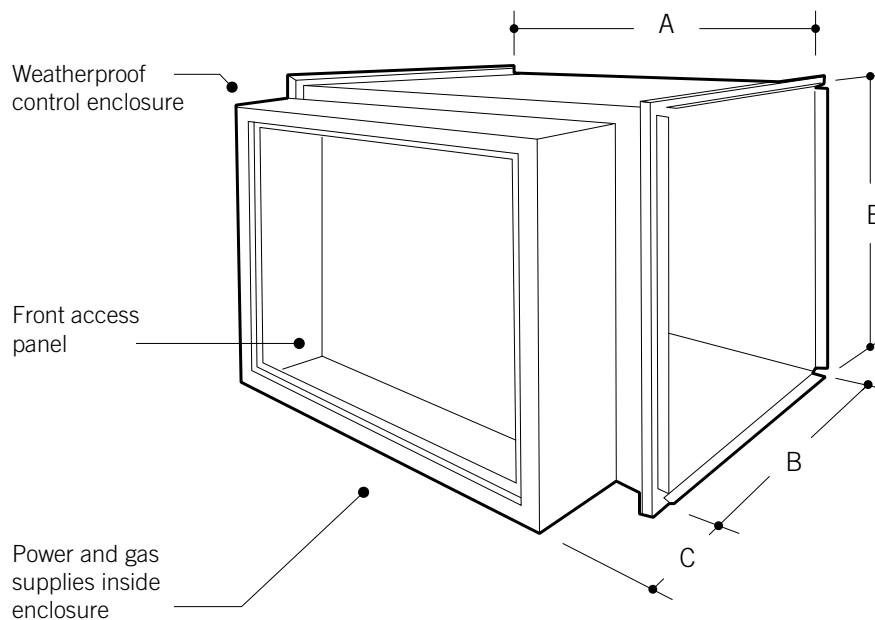

Model	GDH790	GDH1055	GDH1585	GDH2110	GDH2500
A (mm)	1500	1500	1500	1500	1500
B (mm)	990	990	1150	1400	1400
C (mm)	310	310	310	310	310
Approx. Weight (kg)	115	120	145	267	272
Nominal Cooler Match	AL25	AL25	AL30	AL30	AL36
Airflow (L/s) for 42°C Temperature Rise	3,990	5,320	7,985	10,632	12,595
Gas Input (MJ)	790	1,055	1,585	2,110	2,500
Heating Output (kW)	220	293	440	586	694

For higher or lower temperature rise, differing airflows or to match a cooler to the onsite requirements contact Seeley International.

ATH Series

Radiant tube heaters*

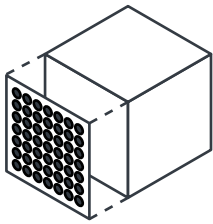

BALL GUARD



UTUBE



STRAIGHT TUBE

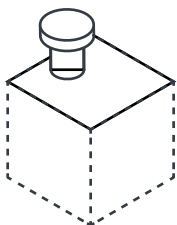

FLUE KIT



Radiant tube heaters use infrared heat that is directed with reflectors, they are easy to install, low maintenance and supply quick and effective heating.

Radiant heat passes through the air only heating the objects that it comes into contact with. Therefore it is unaffected by air temperature, humidity or wind. Flexible installation options make tube heaters ideal for workshops, showrooms, supermarkets, cafes and restaurants.

FEATURES

- No naked flame, the black ray tubing heats and reflects heat towards objects
- Flexible installation options
- 1.6mm gauge aluminised steel tubing
- Fully automatic burner/s
- Low profile
- Gas connection - 1/2" BSP all units
- Single and U-tube options available

OPTIONS

- Flued or un-flued options
- Variety of control options
- Ball guards
- Thermostat control

*Not manufactured by Seeley International.

ATH Series

Radiant tube heaters*

SPECIFICATIONS

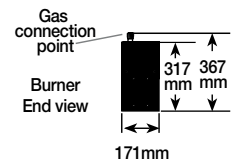
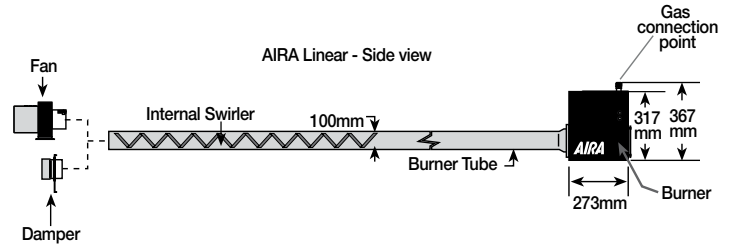
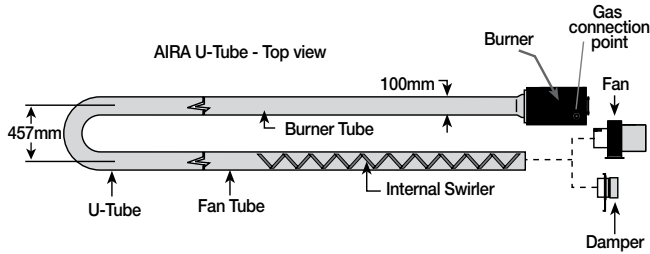

U-Tube (ATH)	15U	20U	25U	30U	35U	40U	45U	50U
Input (MJ/hr)	54	72	90	110	125	138	162	180
Output (kW)	15	20	25	30	35	40	45	50
Length (mm)	3822	5346	5346	6870	6870	6870	8394	8394
Weight (kg)	39	54	54	65	65	66	96	96

Linear (ATH)	15S	20S	25S	30S	35S	45S	50S
Input (MJ/hr)	54	72	90	110	125	162	180
Output (kW)	15	20	25	30	35	45	50
Length (mm)	6661	9709	9709	12757	12767	15815	15815
Weight (kg)	41	55	55	68	68	81	81

Fuel	NG or LPG
Inlet Pressure (kPa)	NG min. 1.13 ULPG min. 2.75 (Butane/propane or ULPG)
Gas Connection (ISO 7-Rc)	½"
Electrical Supply (kg)	230 V, 50Hz, 1 ~, 1A (AH50 only 2A)
Heat Exchanger Tubing	3m sections, 1.6mm guage (pre-heat treated, except first section)
Exhaust Flue/Fresh Air Supply	100mm
Reflector and End Caps	NSH14 aluminium
Ignition	Fully automatic, ThreeTry, direct spark, 100% shut off ignition flame rectification module, volatile lock-out
Approved as	Flueless or flued
AGA Standard	AS 4673-2007 #6399
Accessories	Optional lockout indication (volt free contact)

CLEARANCES TO COMBUSTIBLES** (mm)

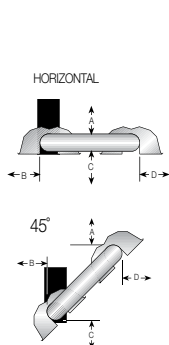

	15U	20U	25U	30U	35U	40U	45U	50U
A	150	150	150	150	150	150	200	200
B	890	970	970	1020	1170	1220	1270	1380
C	1580	1730	1730	1910	1980	2050	2110	2210
D	760	940	940	1000	1090	1150	1200	1300

	15S	20S	25S	30S	35S	45S	50S
A	200	200	200	200	200	200	200
B	200	200	200	200	200	200	200
C	1500	1650	1650	1860	1960	2040	2110
D	1070	1170	1170	1320	1550	1620	1780

	15S	20S	25S	30S	35S	45S	50S
A	150	150	150	150	150	200	200
B	890	970	970	1020	1170	1280	1330
C	1570	1650	1650	1780	1930	2010	2080
D	890	970	970	1020	1170	1280	1330

	15S	20S	25S	30S	35S	45S	50S
A	200	200	200	250	250	300	300
B	200	200	200	200	200	200	200
C	1500	1660	1660	1860	1960	2110	2160
D	1370	1520	1520	1630	1750	1880	2000

*Not manufactured by Seeley International.

**Clearances B, C and D can be reduced by 50% for locations 7m or more downstream of the burner. For more mounting options and associated clearances, please contact Seeley International.

F Series

Gas heaters

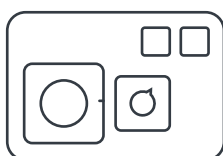

CONTROL PANEL

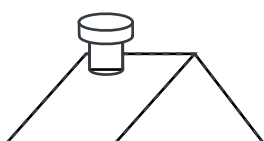

ROOF COWL



ROOM THERMOSTAT

A compact, energy efficient, indirect gas fired, suspended heater. Ideal for door curtains, recreational buildings, shops, workshops and showrooms.

FEATURES

- Stainless steel heat exchanger
- Modulating burner
- Axial fan
- Intermittent pilot
- Horizontal outlet louvres to direct hot air downwards
- 38 to 94 kW capacity and up to 2,400 L/s airflow
- Roof cowl

OPTIONS

- Optional LPG

THROW CHART

Height Above Floor	DU16F		SD40F	
	A	B	A	B
3.2m	22.3	16.7	-	-
3.9m	20.3	15.4	-	-
4.5m	18.7	14.1	33.7	25.5
5.2m	16.7	12.5	31.1	22.9
5.9m	15.0	11.5	28.5	20.6
6.5m	-	-	25.5	18.6

SPECIFICATIONS

Model	DU16F	SD40F
Input (MJ/hr)	168.8	422.0
Output (kW)	38	94
Air Volume (L/s)	934	2436
Motor (W/Amps/Phase)	95/3.0/1	2 x 125/2 x 4.0/1
Fan Diameter (mm)	457	2 x 508
Weight (kg)	98	236



BREEZAIR

Ducted Evaporative Air Conditioning

BRAEMAR

Ducted Evaporative Air Conditioning | Ducted Gas Heating
Reverse Cycle Air Conditioning | Gas Wall Furnaces and Space Heaters

THE CLIMATE WIZARD

Indirect Evaporative Air Conditioning

COOLAIR

Ducted Evaporative Air Conditioning

COOLERADO

Indirect Evaporative Air Conditioning

AIRA

Direct Evaporative Air Conditioning | Ducted Gas Heating
Commercial Gas Space Heating

seeleyinternational.com
1300 475 091
commercial@seeleyinternational.com

Seeley International Pty Ltd
ABN 23 054 687 035

112 O'Sullivan Beach Road, Lonsdale, SA 5160

Phone: (08) 8328 3850 Fax: (08) 8328 3950

Email: commercial@seeleyinternational.com

www.seeleyinternational.com

Information in this brochure was correct at the time of preparation.
Specifications subject to change without any notice. E & OE



FS 605002

Cat No AI0001 REV G (0522)